

Product Manual

UNC-411E-B

Feature Illustration

UNC-411E-B RACKMOUNT CHASSIS

The UNC-411E-B is the flexible 4U E-ATX server rack chassis for even the most demanding systems. The robust build quality with 1.2mm thick SECC steel ensures good protection of the hardware and servers as a reliable and flexible long-term solution. Sufficient cooling options with 1x 120mm front and 2x 80mm rear installation of optionally available fans are provided. Two fast USB 3.1 ports in the front panel add to the features on offer with this chassis.

Specifications:

- Construction: Heavy-duty 1.2mm steel chassis
- Disk Drive Capacity:
 - External : 6x 5.25" , 3x 3.5" , 1x 5.25" slim line ODD
 - Internal : 2x 3.5"
- Cooling System: One front 12cm (optional) and two rear cooling fan
- Controls: Momentary power, recess reset switches
- Optional front USB dual socket
- One-screw-fastened top cover design
- Indicators: LED display for power and HDD 、 LAN 、 Fan fail
- Dimensions (DxWxH): 600mm x 485mm x 177,5mm
- Power Supply: PS2 / Mini Redundant



Top cover disassembly

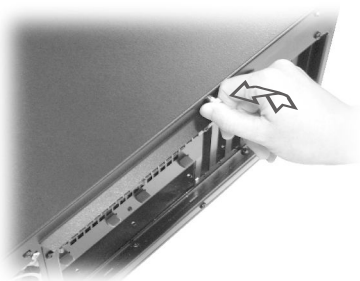

1. Release the thumb screws of the top cover

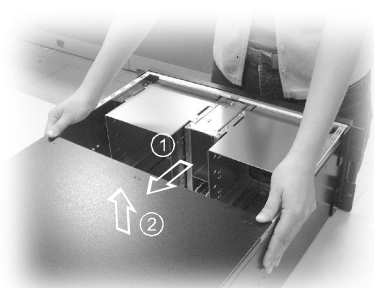

2. Slide back the top cover and lift up

5.25" device installation

(A) 5.25" cage disassembly

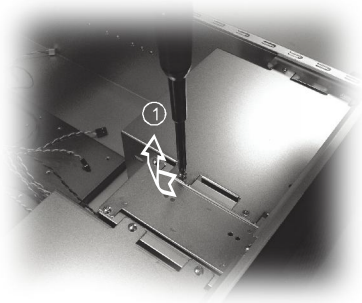

1. Release the screws of the cage

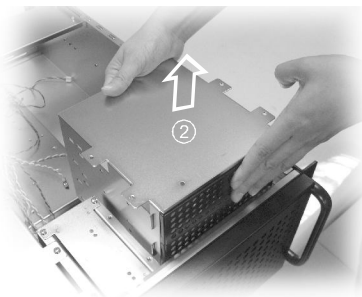

2. Lift up the cage

(B) Dismount the front cover plate

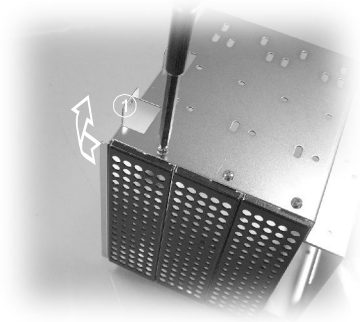

1. Release the screws of the metal cover
2. Remove the metal cover plate from 45 angle

(C) CD-ROM installation

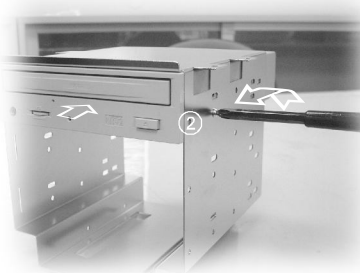

1. Place CD-ROM in the disk cage
2. Affix the CD-ROM to the disk cage with screws

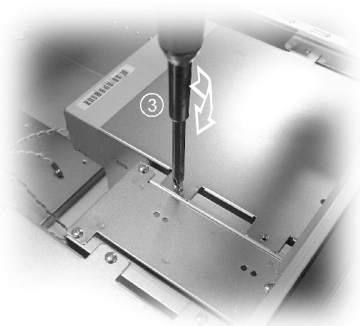

3. Place the disk cage back to the case

(E) HDD / FDD installation in 5.25" device cage



1. Fix the HDD bracket with HDD first
2. Place HDD set in the disk cage
3. Affix the HDD bracket to the disk cage with screws

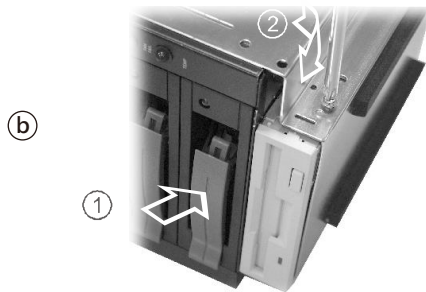

1. Place FDD in the lower disk cage
2. Affix the FDD to the disk cage with screws

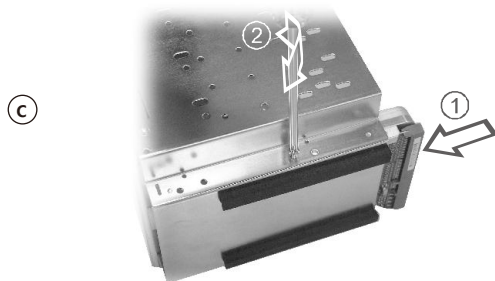

1. Place HDD in the lower disk cage
2. Affix the HDD to the disk cage with screws

(F) Slim CD-ROM installation

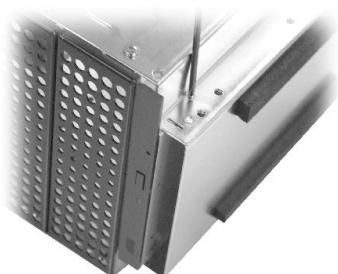

1. Place slim CD-ROM in the lower disk cage
2. Affix the slim CD-ROM to the disk cage with screws

3.5" Device installation

(A) 3.5" cage disassembly

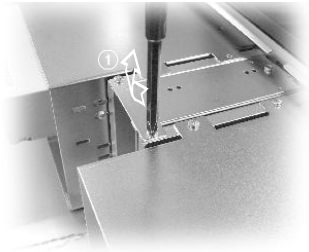

1. Release the screws from 3.5" cage

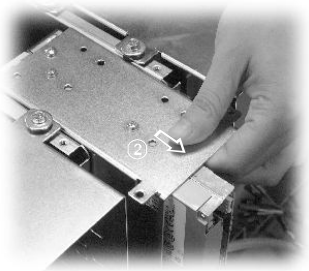

2. Pull out and dismount the 3.5" Cage

(B) Metal cover plate dismount

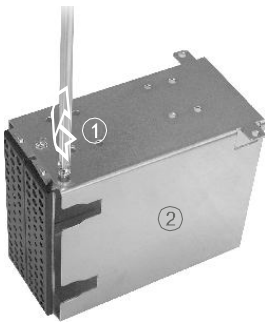

1. Release the screws of metal cover plate

2. Dismount the cover from 45 angle

(C) 3.5" Device installtion

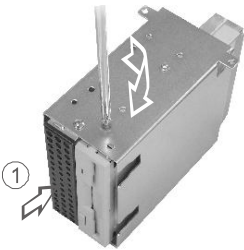

1. Place FDD into the 3.5" cage and affix with screws

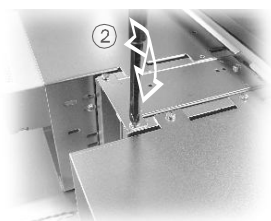

2. Mount the 3.5" cage with screws

Fan filter replacement

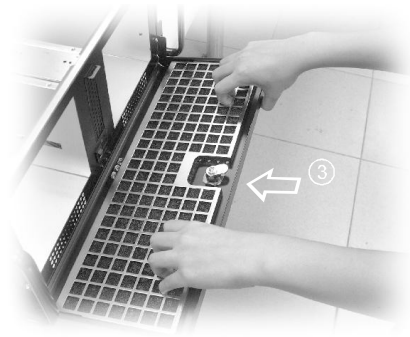

1. Pull out the Filter bracket and remove the used filter.
2. Replace with new fan filter
3. Mount the filter bracket

Fan replacement installation

(A) 12cm fan replacement



1. Replace the screws from the fan bracket on 5.25 device cage

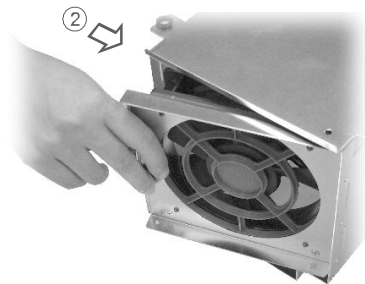

2. Pull out and remove the fan bracket from cage
3. Replace with the new fan

(B) 8cm fan replacement

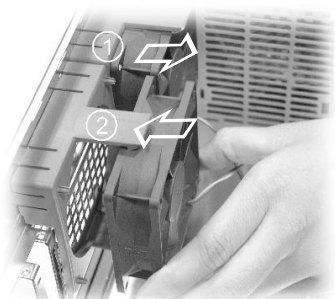

1. Remove the 8cm fan from fan holder
2. Replace with the new fan

Motherboard installation

(A) Interface card bracket installation

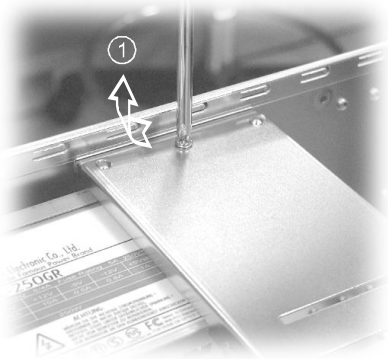

1. Release the screws from bracket
2. Remove the bracket from 45 angle

(B) Motherboard installation

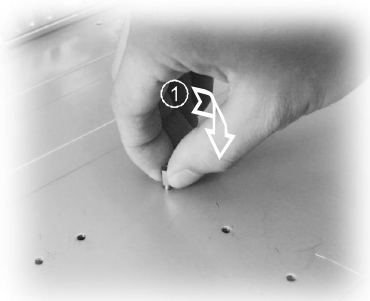

1. Affix the standoffs on the M/B base

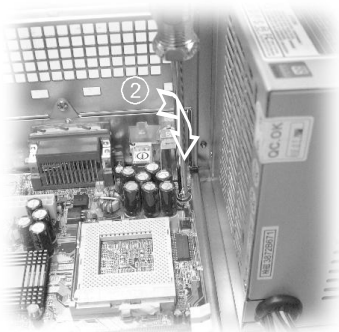

2. Place the motherboard on the stand-offs and affix with #6-32 screws

(C) Interface installation

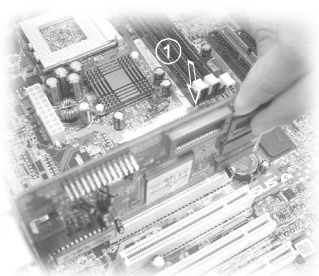

1. Plug the interface card to the motherboard slot

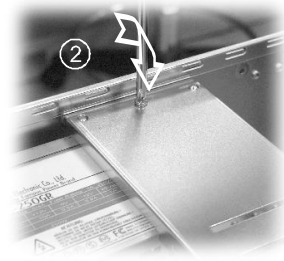
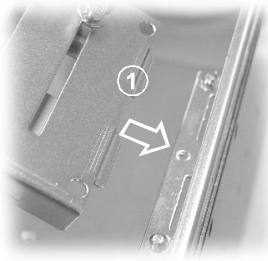

2. Affix the interface card bracket to the case by screw

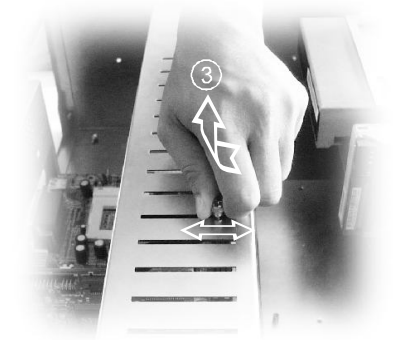

3. Loose the thumb screws to adjust the hold down clamp to the interface card

Note : Do Not take the screws out



4. Affix the hold down clamp with thumb screws

Power supply installation

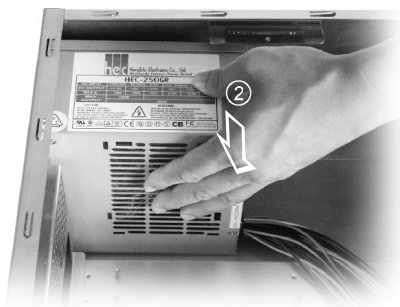

1. Place the power supply into the case



2. Affix the power supply with screws

UNC-411E-B Assembly

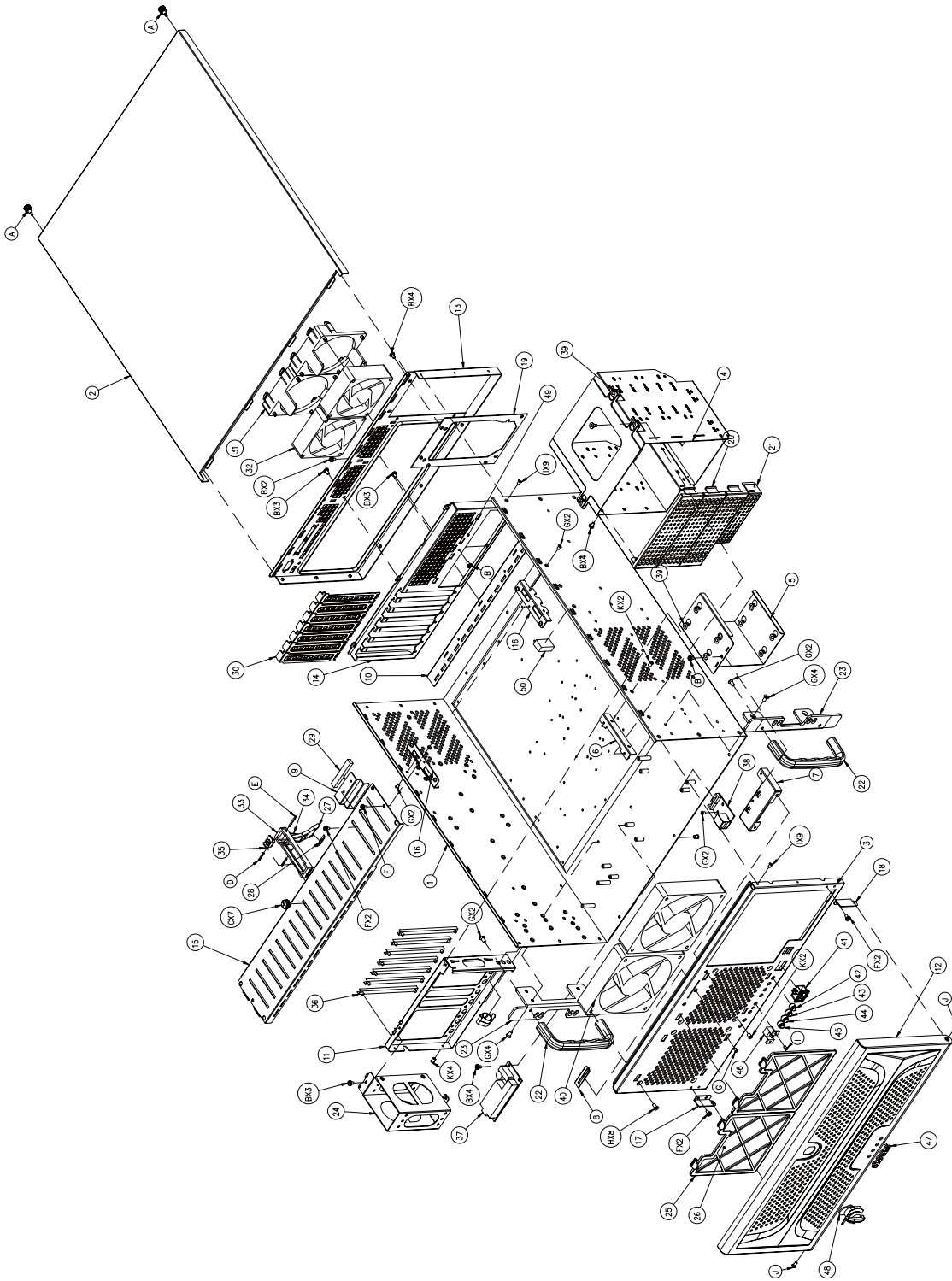

NO	DESCRIPTION	REMARK	QTY
1	Base		1
2	Top Cover		1
3	Front Cover		1
4	5.25" Cage	5.25"×3	1
5	3.5" Cage	3.5"×2	1
6	5.25" Bracket		1
7	3.5" Bracket		1
8	Lock Bracket		1
9	Power Bracket02-Top		1
10	Window Base		1
11	PCB Bracket-1		1
12	Door		1
13	Back cover		1
14	Window		1
15	Hold down Bar		1
16	Hold down Bar Bracket		2
17	Hing01		1
18	Hing02		1
19	Power Bracket	FOR PS2 PWR	1
20	5.25" Apron	5.25"	3
21	3.5" Apron	3.5"	1
22	Handle		2
23	Handle Base		2
24	2.5" Cage	2.5"×3	1
25	Filter Cover		2
26	Filter		2
27	Link02		7
28	Link Rubber		7
29	Power Rubber02		7
30	Slot Apron		7
31	8cm Fan Holder	8025	2
32	8cm Fan	8025	2
33	Link01		7
34	Link03		7
35	Link04		7
36	PCI Guide		7
37	Fan Control Card		1
38	USB		1
39	HDD Rubber		12
40	12cm Fan		2
41	Power Switch	12025	1
42	HDD LED		1
43	HDD LED		1
44	Fan Fail LED		1
45	Fan LED		1
46	Reset Switch		1
47	LED Lens		2
48	Lock		1
49	IO Shielding		1
50	Power Rubber03		1
A	Knob Screw (#6-32)	Top Cover	2
B	Screw (#6-32)		26
C	Knob Screw (#6-32)		7
D	Spring Hing		14
E	Screw (#6-32)	Black	4
F	Screw (#6-32)	Black	12
G	Screw (#6-32)	Black	8
H	Screw (#6-32)	Black	24
I	Screw (#6-32)	Door	2
J	Step Screw (#6-32)		2
K	Rivet		8



Arena Electronic GmbH
Germany



MADE IN CHINA